

CPU-HOUDER COMP03

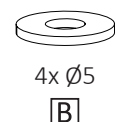

STAP 1

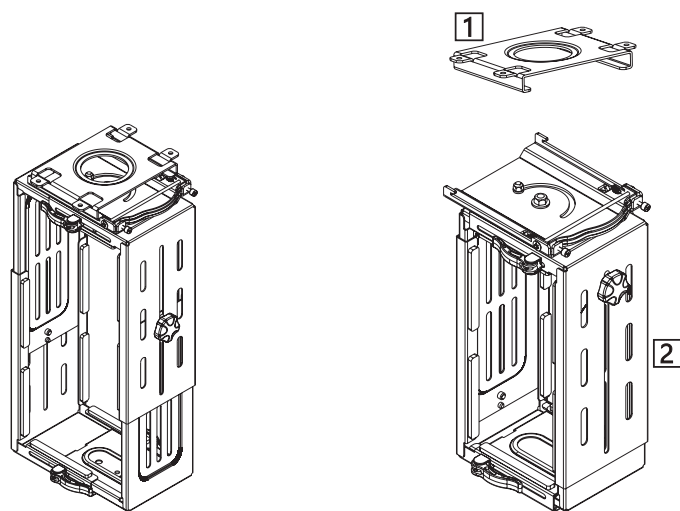
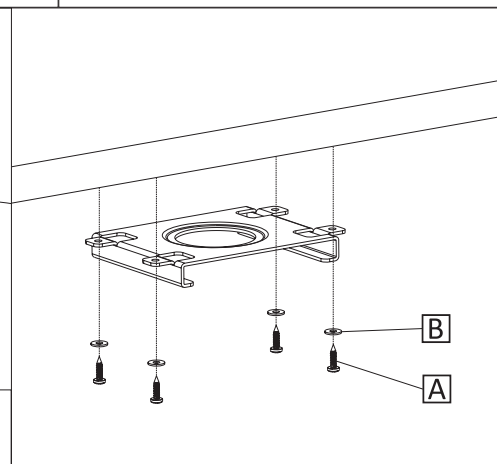
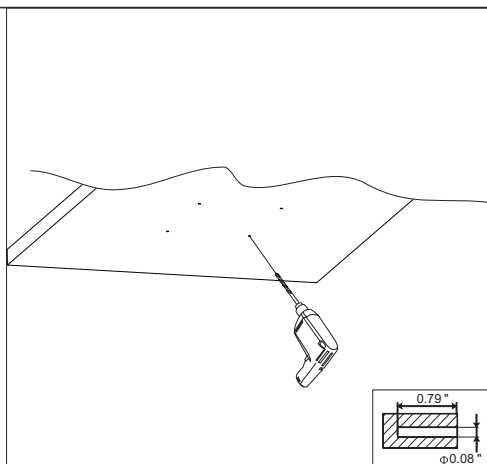
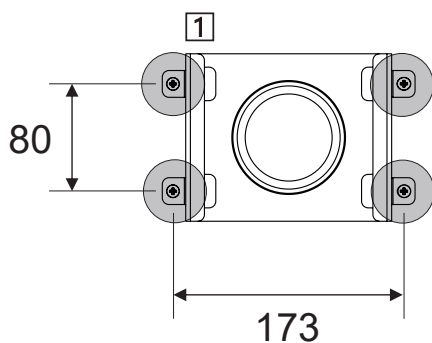

1.1 Plaats de beugel onder op het blad en markeer de gaten.

1.2 Boor gaten op de markeringen.
Let op: boor niet door het blad heen, een ondiep gaatje is voldoende.

1.2 Plaats de beugel en schroef deze vast met de bijgeleverde schroeven(A)

STAP 2

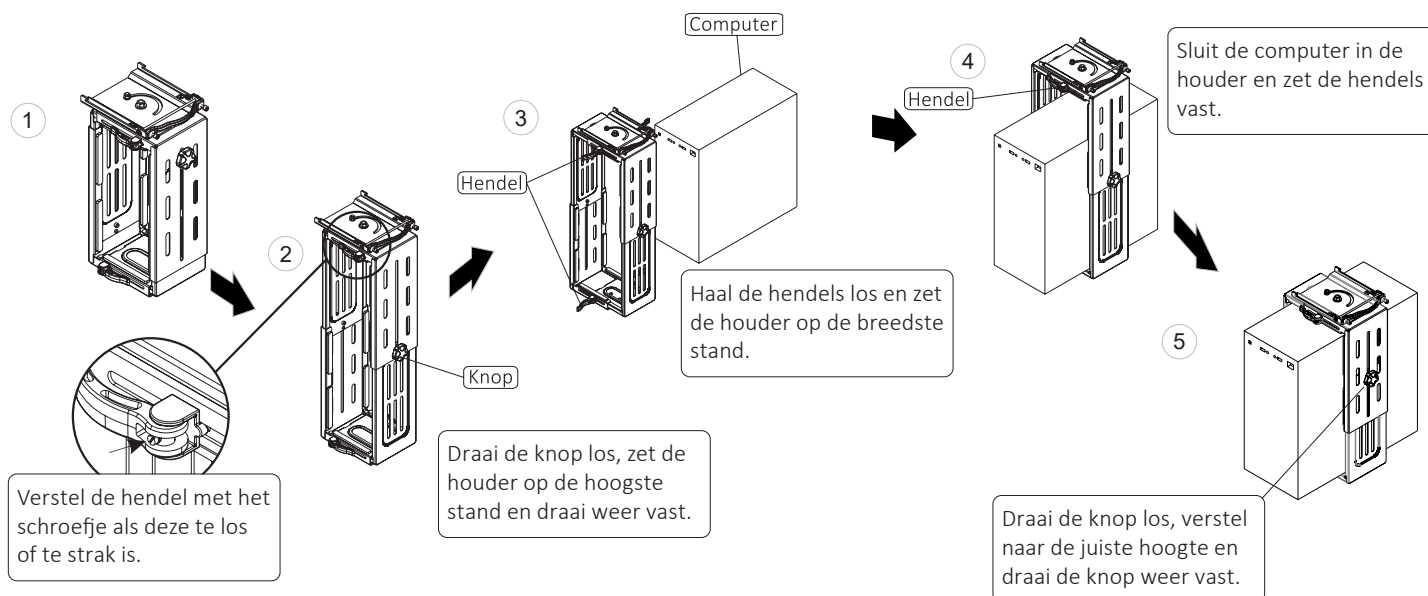

STAP 3

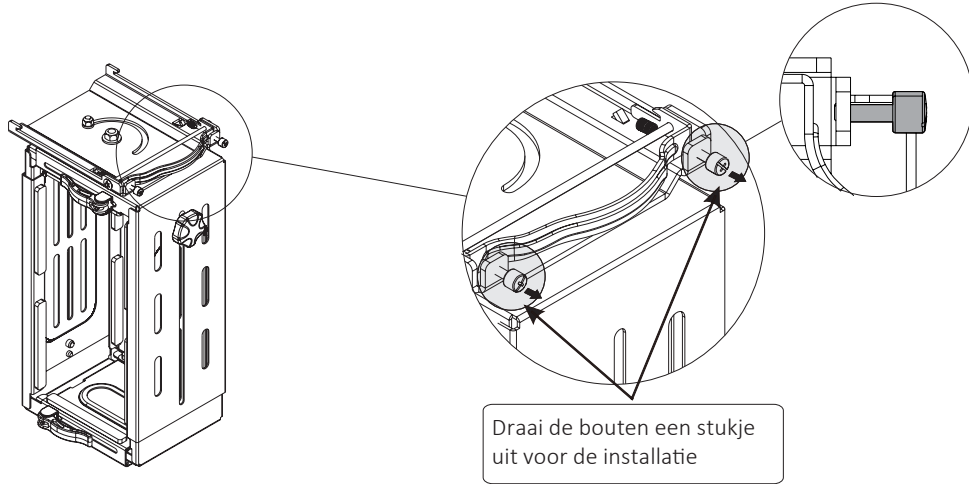

STAP 4

